

Specifications

Wafer

備注 (Remark)

1. 材料 (Material)

膠芯: PA66 UL94V-0

Housing: PA66 UL94V-0

端子: 黃銅

Contact: Brass

2564WV-XX-NOSN

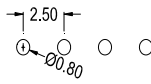
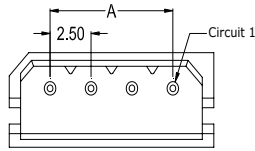

PCB LAYOUT



2564WV-XX-NOSN

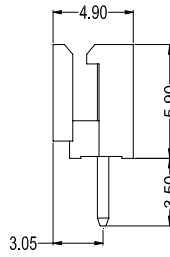
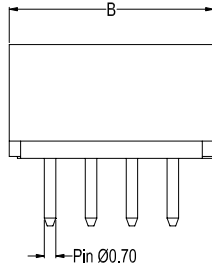

Poles	Dimensions (mm)	
	A	B
02	2.50	7.50
03	5.00	10.00
04	7.50	12.50
05	10.00	15.00
06	12.50	17.50
07	15.00	20.00
08	17.50	22.00
09	20.00	25.00
10	22.50	27.50
11	25.00	30.00
12	27.50	32.50
13	30.00	35.00
14	32.50	37.50
15	35.00	40.00
16	37.50	42.50

2564WV-XX-NOSN	Nylon 66 UL 94V-0	Brass	Tin-Plated	2564H	1,000Pcs
PART NO	Material	Material(Pin)	Finish(Pin)	Mates With SWB Housing	Q'ty/Bag

Housing

備注 (Remark)

1. 材料 (Material)

膠芯: PA66 UL94V-0

Housing: PA66 UL94V-0

2564H-XX-N0

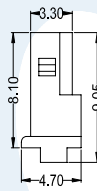
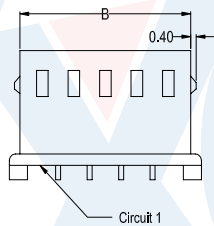
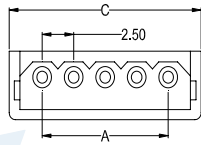

2564H-XX-N0

Poles	Dimensions (mm)		
	A	B	C
02	2.50	5.90	7.50
03	5.00	8.40	10.00
04	7.50	10.90	12.50
05	10.00	13.40	15.00
06	12.50	15.90	17.50
07	15.00	18.40	20.00
08	17.50	20.90	22.50
09	20.00	23.40	25.00
10	22.50	25.90	27.50
11	25.00	28.40	30.00
12	27.50	30.90	32.50
13	30.00	33.40	35.00
14	32.50	35.90	37.50
15	35.00	38.40	40.00
16	37.50	40.90	42.50

2564H-XX-N0HF	Nylon 66 UL 94V-0 Halogen Free	2564T	2564W	1,000Pcs
2564H-XX-N0	Nylon 66 UL 94V-0	Suitable CSWB Terminal	Mates With SWB Wafer	Q'ty/Bag
PART NO	Material	Suitable CSWB Terminal	Mates With SWB Wafer	Q'ty/Bag

Terminal

備注 (Remark)

1. 材料 (Material)

端子: 黃銅

Contact: Brass

2564T-XSN

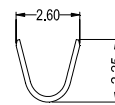
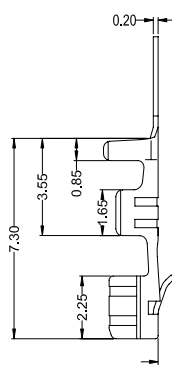
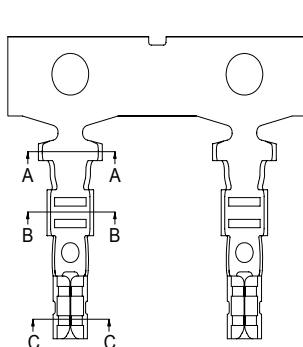

SECTION: A-A
SCALE: 1:1

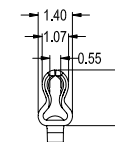

SECTION: C-C
SCALE: 1:1



SECTION: B-B
SCALE: 1:1



2564T-XSN

2564T-BSNB	Brass	AWG#22-28	1.90mm(Max)	Plating Before Stamping: 10~30u" Ni; 40~60u" Sn	2564H	10,000Pcs
2564T-BSN	Brass			Stamping Before Plating: 30~50u" Ni; 70~120u" Sn		
2564T-PSN	Phosphor Bronze					
PART NO	Material	Wire Range	Insulation O.D.	Finish	Used In SWB Housing	Q'ty/Reel