

**Specifications**

備注 (Remark)

1. 材料 (Material)

膠芯: PA9T/LCP+30% G.F UL94V-0, 顏色: 黑色

Housing: PA9T/LCP+30% G.F UL94V-0,

Color: Black

端子: 磷銅

Contact: Phosphor Bronze

2. 特性 (characteristics):

額定電流: 1.0AMP

Rating Current: 1.0AMP

接觸阻抗: 20mΩ Max

Contact Resistance: 20mΩ Max

絕緣阻抗: 1000MΩ Min

Insulating Resistance: 1000 MΩ Min

耐電壓: AC 500V/分鐘

Withstanding Voltage: AC 500V/Minute

溫度範圍: -55° C to +125° C

Temperture Range: -55° C to +125° C

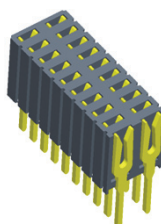

F446-12XXXXXSYX1

Mating With/配對公座:  
P417/P425

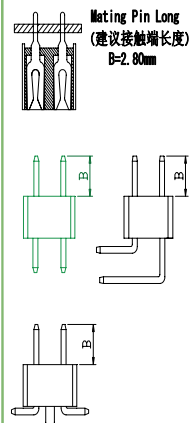

FEMALE HEADER

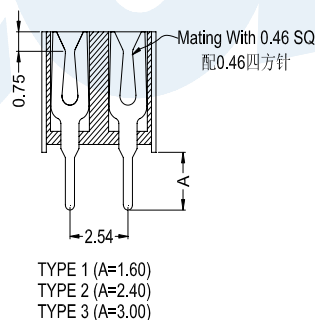
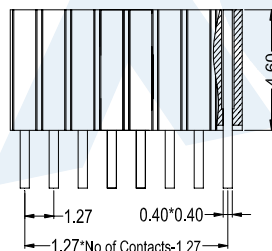
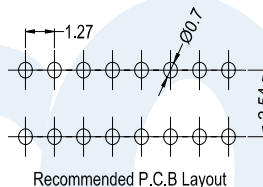
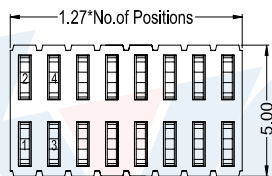

**F 4 4 6 - 1 2**

**XX**

**XX**

**X**

**S**

**Y**

**X**

**X**

**No.Of Pins Per Row**  
02~50P

**Contact Plating**  
Full Of Gold A0=0.8u"  
Semi-Gold B0=0.8U"  
~ ~  
A9=30u" B9=30U"  
S1=Ordinary Tin Plated  
S2=Matte Tin Plated  
S3=Tin-plated High-temperature

**Insulator Material:**  
B:PA6T  
C:PA9T  
D:LCP

**Packing**  
A:PE Bag  
B:Tape & Reel  
C:Tube  
D:Tube+CAP  
E:Tray

**Journal Number**  
1:Type1  
2:Type2  
3:Type3

Http://www.yxcon.com

E-mail:yx@yxcon.com

YUXI DONGGUAN (東莞)  
YUXI TAIWAN (台灣)

TEL:+86 769 85397456  
TEL:+886 3313 2933

FAX:+86 769 85396015  
FAX:+886 3313 2935

## Specifications

### 備注 (Remark)

#### 1. 材料 (Material)

膠芯: PA9T/LCP+30% G. F UL94V-0, 顏色: 黑色

Housing: PA9T/LCP+30% G. F UL94V-0,

Color: Black

端子: 磷銅

Contact: Phosphor Bronze

#### 2. 特性 (characteristics):

額定電流: 1.0AMP

Rating Current: 1.0AMP

接觸阻抗: 20mΩ Max

Contact Resistance: 20mΩ Max

絕緣阻抗: 1000MΩ Min

Insulating Resistance: 1000 MΩ Min

耐電壓: AC 500V/分鐘

Withstanding Voltage: AC 500V/Minute

溫度範圍: -55° C to +125° C

Temperature Range: -55° C to +125° C

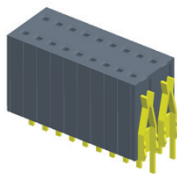

F457-12XXXXXSUX1

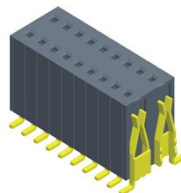

F457-12XXXXXMUX1

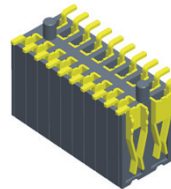

F457-12XXXXXMUX2

Mating With/配對公座:  
PA17/PA25

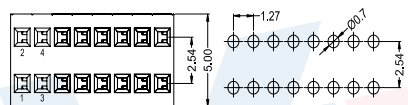
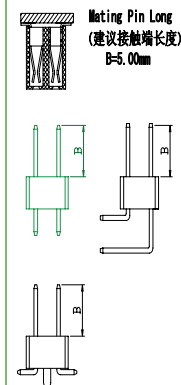

Recommended P.C.B Layout

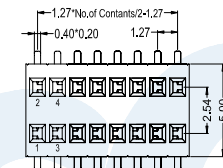
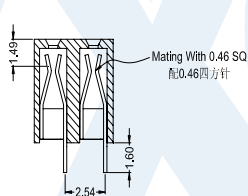
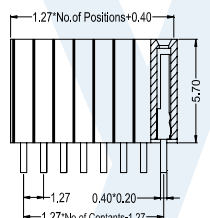

Recommended P.C.B Layout

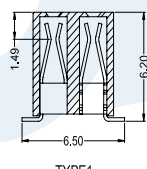
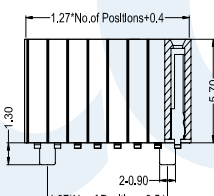

TYPE1

TYPE2

FEMALE HEADER

F 4 5 7 - 12

XX

XX

X

X

U

X

X

No.Of Pins Per Row  
02~50P

Contact Plating  
Full Of Gold A0=0.8u"  
Semi-Gold B0=0.8U"

Insulator Material:  
B:PA6T  
C:PA9T  
D:LCP

Contact Shape:  
S: Straight  
M: SMT

Packing  
A: PE Bag  
B: Tape & Reel  
C: Tube  
D: Tube+CAP  
E: Tray

Journal Number  
1: Type1  
2: Type2

A9=30u" B9=30U"  
S1=Ordinary Tin Plated  
S2=Matte Tin Plated  
S3=Tin-plated High-temperature

Http://www.yxcon.com

E-mail:yx@yxcon.com

YUXI DONGGUAN (東莞)  
YUXI TAIWAN (台灣)

TEL:+86 769 85397456  
TEL:+886 3313 2933

FAX:+86 769 85396015  
FAX:+886 3313 2935

**Specifications**

備注 (Remark)

1. 材料 (Material)

膠芯: PA9T/LCP+30% G.F UL94V-0, 顏色: 黑色

Housing: PA9T/LCP+30% G.F UL94V-0,

Color: Black

端子: 磷銅

Contact: Phosphor Bronze

2. 特性 (characteristics):

額定電流: 1.0AMP

Rating Current: 1.0AMP

接觸阻抗: 20mΩ Max

Contact Resistance: 20mΩ Max

絕緣阻抗: 1000MΩ Min

Insulating Resistance: 1000 MΩ Min

耐電壓: AC 500V/分鐘

Withstanding Voltage: AC 500V/Minute

溫度範圍: -55° C to +125° C

Temperture Range: -55° C to +125° C

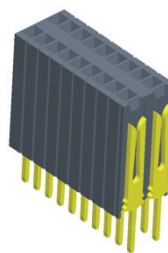

F485-12XXXXXSYX1

Mating With/配對公座:  
P427/P425

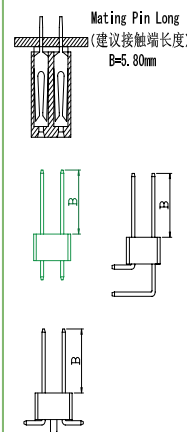

FEMALE HEADER

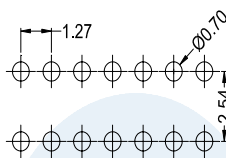
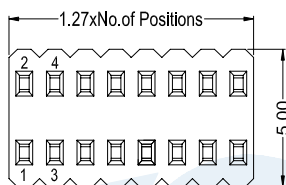

Recommended P.C.B Layout

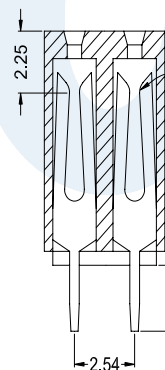
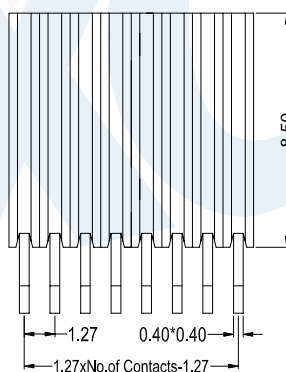

Mating With 0.46 SQ  
配0.46四方針

TYPE 1(A=1.60)  
TYPE 2(A=2.40)  
TYPE 3(A=3.00)

F 4 8 5 - 1 2

XX

XX

X S

Y

X

X

No.Of Pins Per Row  
02~50P

Contact Plating  
Full Of Gold A0=0.8u"  
Semi-Gold B0=0.8U"  
~ ~  
A9=30u" B9=30U"  
S1=Ordinary Tin Plated  
S2=Matte Tin Plated  
S3=Tin-plated High-temperature

Insulator Material:  
B:PA6T  
C:PA9T  
D:LCP

Packing  
A:PE Bag  
B:Tape & Reel  
C:Tube  
D:Tube+CAP  
E:Tray

Journal Number  
1:Type1  
2:Type2  
3:Type3